



European Power-Semiconductor and Electronics Company

Marketing Information

T 218 N

www.DataSheet4U.com

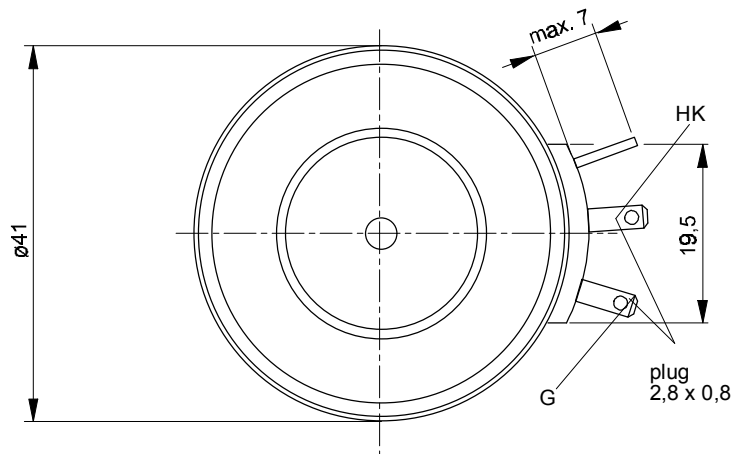
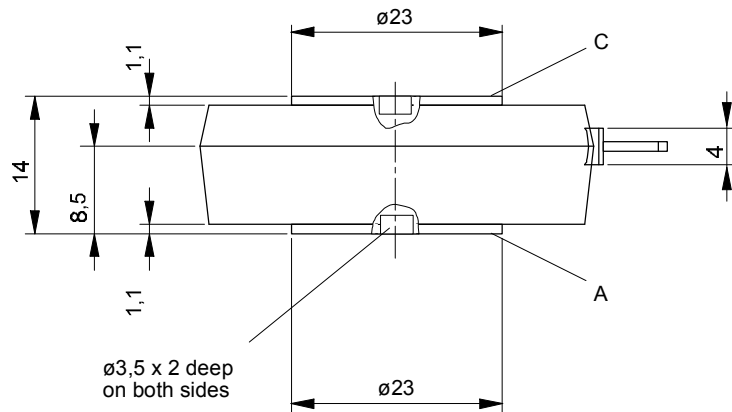

T 218 N

Elektrische Eigenschaften

Höchstzulässige Werte

Periodische Vorwärts- und Rückwärts-Spitzensperrspannung

Electrical properties

Maximum rated values

repetitive peak forward off-state and reverse voltages

Vorwärts-Stoßspitzensperrspannung

non-repetitive peak forward off-state voltage

Rückwärts-Stoßspitzensperrspannung

non-repetitive peak reverse voltage

Durchlaßstrom-Grenzeffektivwert

RMS on-state current

Dauergrenzstrom

average on-state current

Stoßstrom-Grenzwert

surge current

Grenzlastintegral

$I^2 t$ -value

Kritische Stromsteilheit

critical rate of rise of on-state current

Kritische Spannungssteilheit

critical rate of rise of off-state voltage

Charakteristische Werte

Durchlaßspannung

on-state voltage

Schleusenspannung

threshold voltage

Ersatzwiderstand

slope resistance

Zündstrom

gate trigger current

Zündspannung

gate trigger voltage

Nicht zündender Steuerstrom

gate non-trigger current

Nicht zündende Steuerspannung

gate non-trigger voltage

Haltestrom

holding current

Einraststrom

latching current

Vorwärts- und Rückwärts-Sperrstrom

forward off-state and reverse currents

Zündverzug

gate controlled delay time

Freiwerdezeit

circuit commutated turn-off time

Thermische Eigenschaften

Innerer Wärmewiderstand für beidseitige Kühlung

Thermal properties

thermal resistance, junction to case for two-sided cooling

für anodenseitige Kühlung

for anode-sided cooling

für kathodenseitige Kühlung

for cathode-sided cooling

Übergangs-Wärmewiderstand

thermal resistance, case to heatsink

Höchstzul. Sperrschichttemperatur

max. junction temperature

Betriebstemperatur

operating temperature

Lagertemperatur

storage temperature

Mechanische Eigenschaften

Si-Elemente mit Druckkontakt

Mechanical properties

Si-pellet with pressure contact

Anpreßkraft

clamping force

Gewicht

weight

Kriechstrecke

creepage distance

Feuchteklasse

humidity classification

Schwingfestigkeit

vibration resistance

Maßbild, anliegend

outlines, attached

$t_{vj} = -40^{\circ}\text{C} \dots t_{vj\text{ max}}$	$V_{\text{DRM}}, V_{\text{RRM}}$	600 800 1000 1200 1400 1600 1800	V
$t_{vj} = -40^{\circ}\text{C} \dots t_{vj\text{ max}}$	$V_{\text{DSM}} = V_{\text{DRM}}$	600 800 1000 1200 1400 1600 1800	V
$t_{vj} = +25^{\circ}\text{C} \dots t_{vj\text{ max}}$	$V_{\text{RSM}} = V_{\text{RRM}}$	700 900 1100 1300 1500 1700 1900	V
$t_c = 85^{\circ}\text{C}$	I_{TRMSM}	400	A
$t_c = 75^{\circ}\text{C}$	I_{TAVM}	218	A
$t_{vj} = 25^{\circ}\text{C}, t_p = 10\text{ ms}$	I_{TSM}	3800	A
$t_{vj} = t_{vj\text{ max}}, t_p = 10\text{ ms}$		3400	A
$t_{vj} = 25^{\circ}\text{C}, t_p = 10\text{ ms}$	$I^2 t$	72000	A^2s
$t_{vj} = t_{vj\text{ max}}, t_p = 10\text{ ms}$		58000	A^2s
$V_D \leq 67\%, V_{\text{DRM}}, f = 50\text{ Hz}$	$(di_T/dt)_{cr}$	150	$\text{A}/\mu\text{s}$
$V_L = 10\text{ V}, i_{\text{GM}} = 0,75\text{ A}, di_G/dt = 0,75\text{ A}/\mu\text{s}$			
$t_{vj} = t_{vj\text{ max}}, V_D = 67\% V_{\text{DRM}}$	$(dv/dt)_{cr}$	1000	$\text{V}/\mu\text{s}$

$t_{vj} = t_{vj\text{ max}}, i_T = 800\text{ A}$	V_T	max. 2,2	V
$t_{vj} = t_{vj\text{ max}}$	$V_{T(\text{TO})}$	0,9	V
$t_{vj} = t_{vj\text{ max}}$	r_T	1,35	$\text{m}\Omega$
$t_{vj} = 25^{\circ}\text{C}, V_D = 6\text{ V}$	I_{GT}	max. 150	mA
$t_{vj} = 25^{\circ}\text{C}, V_D = 6\text{ V}$	V_{GT}	max. 2	V
$t_{vj} = t_{vj\text{ max}}, V_D = 6\text{ V}$	I_{GD}	max. 10	mA
$t_{vj} = t_{vj\text{ max}}, V_D = 0,5 V_{\text{DRM}}$	V_{GD}	max. 0,25	V
$t_{vj} = 25^{\circ}\text{C}, V_D = 6\text{ V}, R_A = 5\ \Omega$	I_H	max. 200	mA
$t_{vj} = 25^{\circ}\text{C}, V_D = 6\text{ V}, R_{\text{GK}} \geq 10\ \Omega$	I_L	max. 800	mA
$i_{\text{GM}} = 0,75\text{ A}, di_G/dt = 0,75\text{ A}/\mu\text{s}, t_g = 20\ \mu\text{s}$			
$t_{vj} = t_{vj\text{ max}}, V_D = V_{\text{DRM}}, V_R = V_{\text{RRM}}$	i_D, i_R	max. 30	mA
$t_{vj} = 25^{\circ}\text{C}, i_{\text{GM}} = 0,75\text{ A}, di_G/dt = 0,75\text{ A}/\mu\text{s}$	t_{gd}	max. 4,5	μs
siehe Techn.Erl./see Techn. Inf.	t_q	typ. 200	μs

$\Theta = 180^{\circ}\text{ el, sin}$	R_{thJC}	max. 0,111	$^{\circ}\text{C}/\text{W}$
DC		max. 0,103	$^{\circ}\text{C}/\text{W}$
$\Theta = 180^{\circ}\text{ el, sin}$	$R_{\text{thJC(A)}}$	max. 0,174	$^{\circ}\text{C}/\text{W}$
DC		max. 0,166	$^{\circ}\text{C}/\text{W}$
$\Theta = 180^{\circ}\text{ el, sin}$	$R_{\text{thJC(K)}}$	max. 0,274	$^{\circ}\text{C}/\text{W}$
DC		max. 0,266	$^{\circ}\text{C}/\text{W}$
beidseitig/two-sided		max. 0,015	$^{\circ}\text{C}/\text{W}$
einseitig/one-sided		max. 0,030	$^{\circ}\text{C}/\text{W}$
$t_{vj\text{ max}}$		125	$^{\circ}\text{C}$
$t_{c\text{ op}}$		-40...+125	$^{\circ}\text{C}$
t_{stg}		-40...+140	$^{\circ}\text{C}$

F		2,5...5	kN
G		typ. 70	g
		17	mm
DIN 40040			C
$f = 50\text{ Hz}$		50	m/s^2
DIN 41814-151A4			

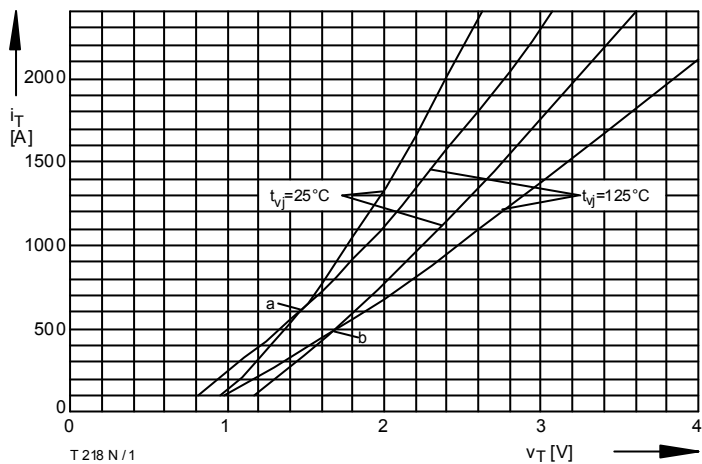

T 218 N / 1

Bild / Fig. 1
 Durchlaßkennlinie / On-state characteristic $i_T = f(v_T)$
 a - Typische Kennlinien / typical characteristics
 b - Grenzkennlinien / limiting characteristics

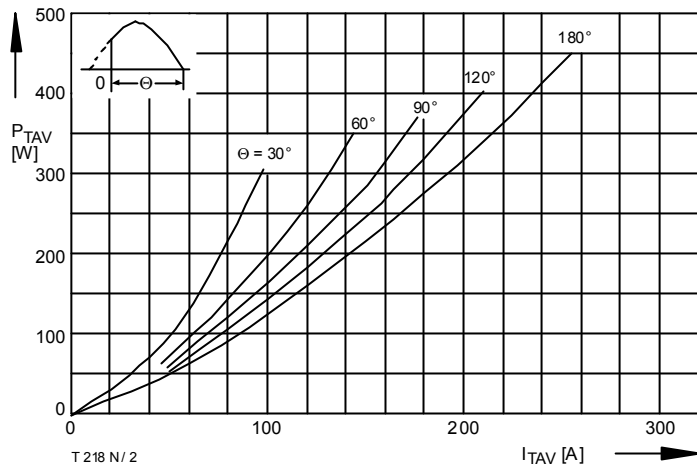

T 218 N / 2

Bild / Fig. 2
 Durchlaßverlustleistung / On-state power loss $P_{TAV} = f(I_{TAV})$
 Parameter: Stromflußwinkel / Current conduction angle θ

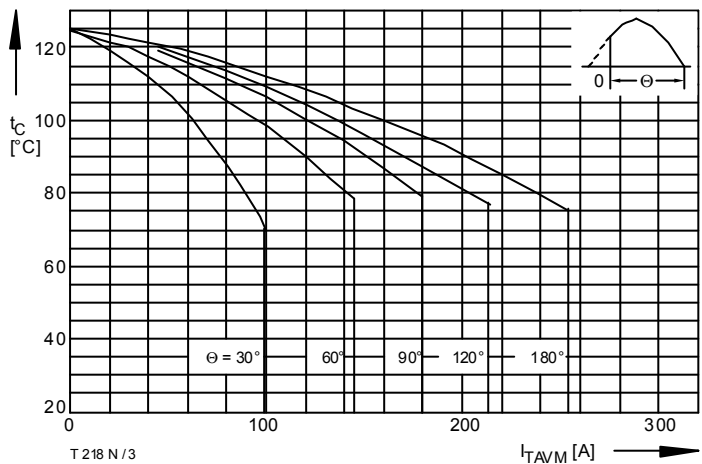

T 218 N / 3

Bild / Fig. 3
 Höchstzulässige Gehäusetemperatur / Max. allowable case temperature
 $t_c = f(I_{TAVM})$
 Beidseitige Kühlung / Two-sided cooling
 Parameter: Stromflußwinkel / Current conduction angle θ

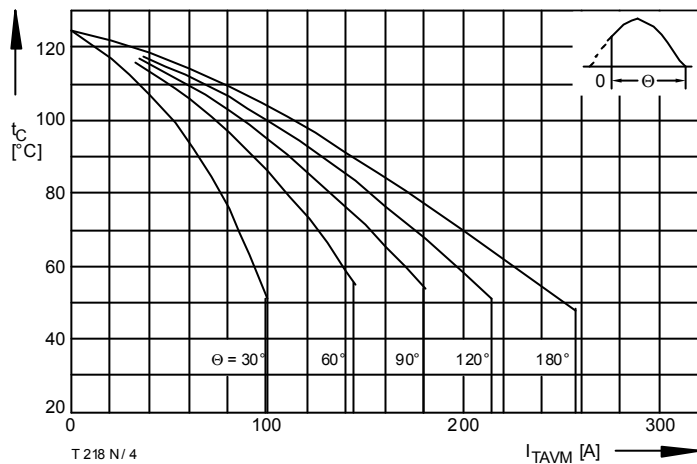

T 218 N / 4

Bild / Fig. 4
 Höchstzulässige Gehäusetemperatur / Max. allowable case temperature
 $t_c = f(I_{TAVM})$
 Anodenseitige Kühlung / Anode-sided cooling
 Parameter: Stromflußwinkel / Current conduction angle θ

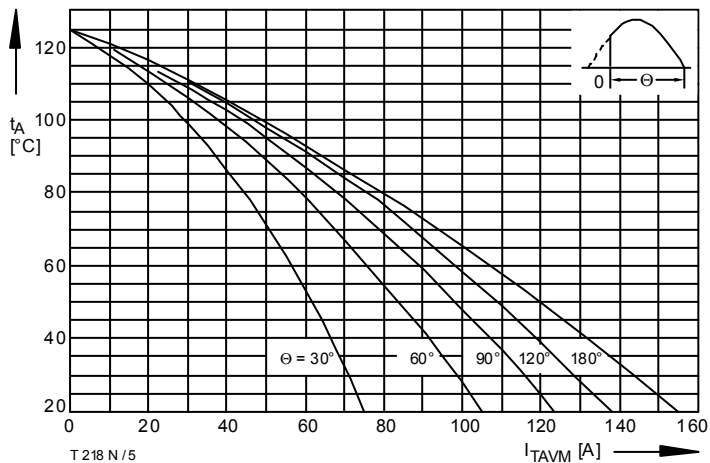

T 218 N / 5

Bild / Fig. 5
 Höchstzulässige Kühlmitteltemperatur / Max. allowable cooling medium temperature
 $t_A = f(I_{TAVM})$
 Luftselbstkühlung / Natural air-cooling
 Kühlkörper / Heatsink: K0.36S
 Parameter: Stromflußwinkel / Current conduction angle θ

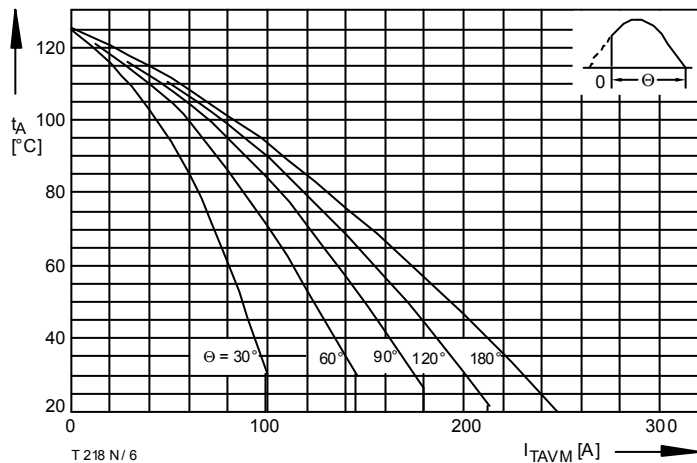

T 218 N / 6

Bild / Fig. 6
 Höchstzulässige Kühlmitteltemperatur / Max. allowable cooling medium temperature
 $t_A = f(I_{TAVM})$
 Verstärkte Luftkühlung / Forced air cooling
 Kühlkörper / Heatsink: K0.12F, $V_L = 50$ l/s
 Parameter: Stromflußwinkel / Current conduction angle θ

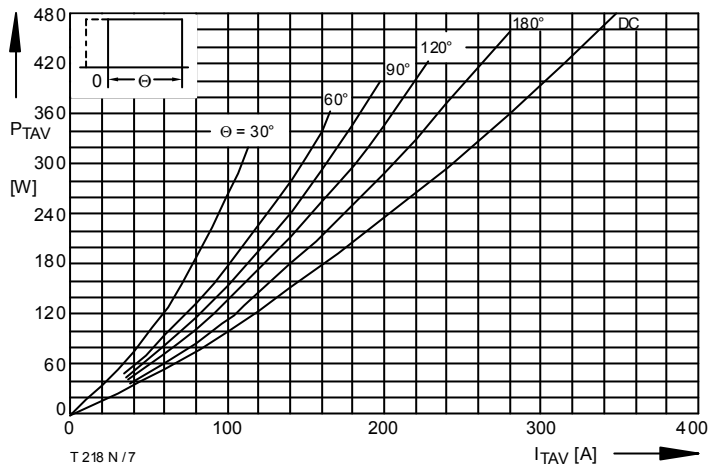

T 218 N / 7

Bild / Fig. 7
Durchlaßverlustleistung / On-state power loss $P_{TAV} = f(I_{TAV})$
Parameter: Stromflußwinkel / Current conduction angle θ

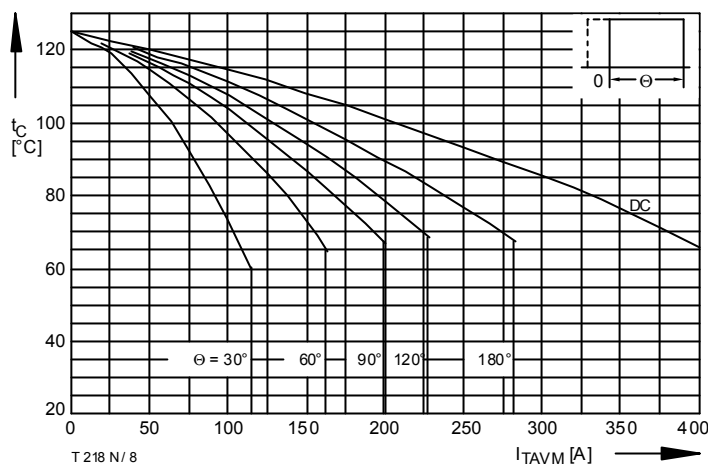

T 218 N / 8

Bild / Fig. 8
Höchstzulässige Gehäusetemperatur / Max. allowable case temperature $t_c = f(I_{TAVM})$
Beidseitige Kühlung / Two-sided cooling
Parameter: Stromflußwinkel / Current conduction angle θ

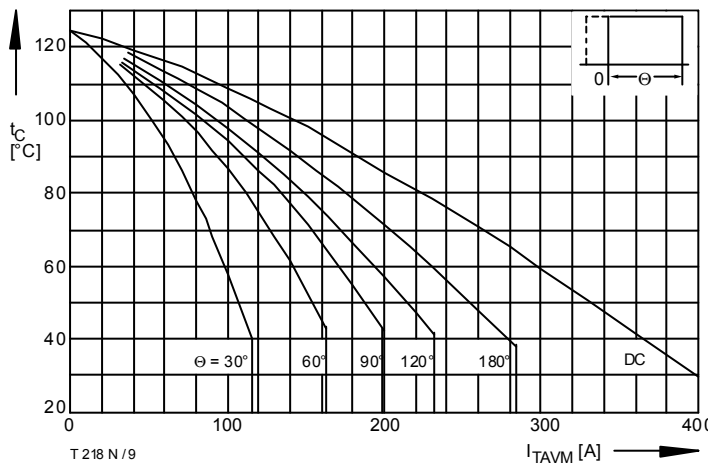

T 218 N / 9

Bild / Fig. 9
Höchstzulässige Gehäusetemperatur / Max. allowable case temperature $t_c = f(I_{TAVM})$
Anodenseitige Kühlung / Anode-sided cooling
Parameter: Stromflußwinkel / Current conduction angle θ

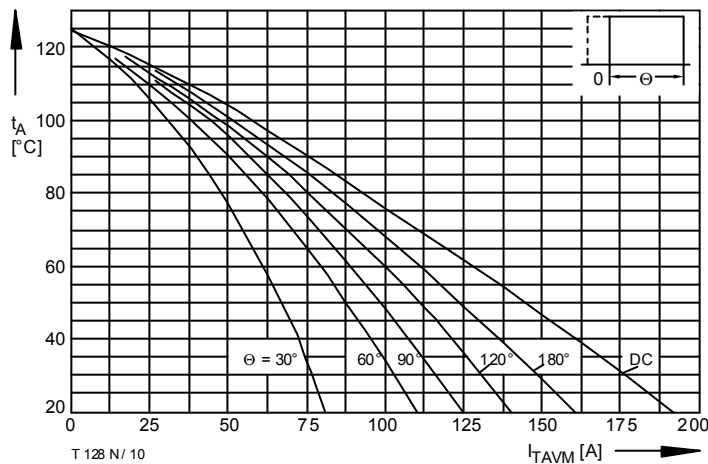

T 128 N / 10

Bild / Fig. 10
Höchstzulässige Kühlmitteltemperatur / Max. allowable cooling medium temperature $t_A = f(I_{TAVM})$
Luftselbstkühlung / Natural air-cooling
Kühlkörper / Heatsink: K0.36S
Parameter: Stromflußwinkel / Current conduction angle θ

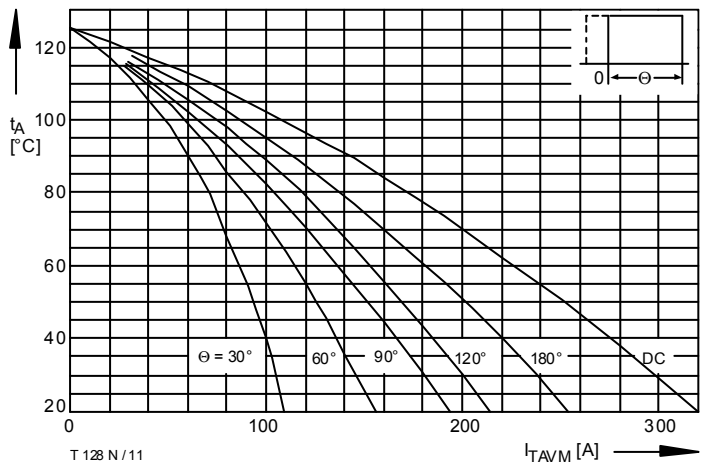

T 128 N / 11

Bild / Fig. 11
Höchstzulässige Kühlmitteltemperatur / Max. allowable cooling medium temperature $t_A = f(I_{TAVM})$
Verstärkte Luftkühlung / forced air cooling
Kühlkörper / Heatsink: K0.12F, $V_L = 50$ l/s
Parameter: Stromflußwinkel / Current conduction angle θ

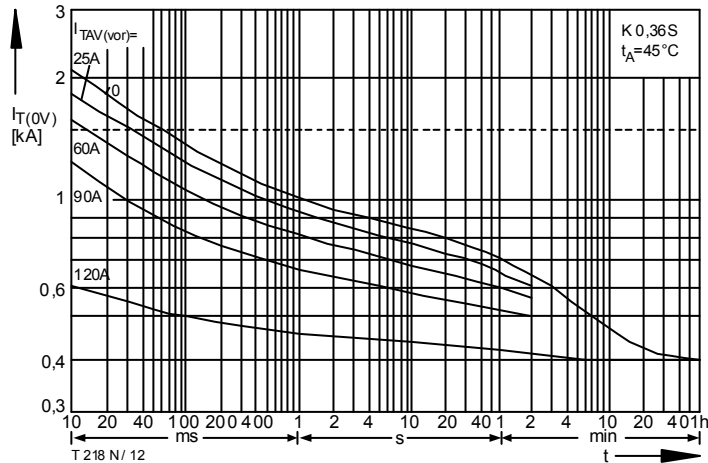

T 218 N / 12

Bild / Fig. 12
Überstrom / Overload on-state current $I_{T(OV)} = f(t)$
Luftselbstkühlung / Natural air-cooling $t_A = 45^\circ\text{C}$
Kühlkörper / Heatsink: K0.36S
Parameter: Vorlaststrom / Pre-load current $I_{TAV(vor)}$



Bild / Fig. 13
 Überstrom / Overload on-state current $I_{T(OV)} = f(t)$
 Verstärkte Luftkühlung / Forced air-cooling, $t_A = 35^\circ\text{C}$
 Kühlkörper / Heatsink: K0,12F, $v_L = 50\text{ l/s}$
 Parameter: Vorlaststrom / Pre-load current $I_{TAV(vor)}$



Bild / Fig. 14
 Höchstzulässiger Durchlaßstrom bei Aussetzbetrieb / Max. allowable on-state current at intermittent operation $I_{TINT} = f(ED)$
 Luftselbstkühlung / Natural air-cooling, $t_A = 45^\circ\text{C}$
 Kühlkörper / Heatsink: K0,36S
 Parameter: Spieldauer / Cycle duration SD
 Vorlaststrom / Pre-load current $I_{TAV(vor)}$

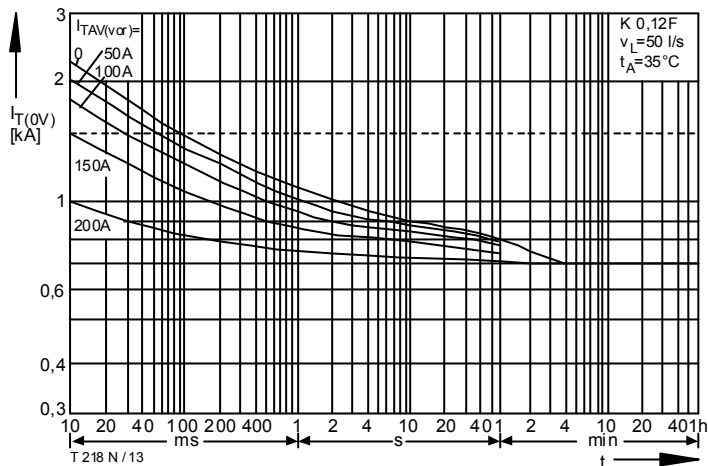

Bild / Fig. 15
 Höchstzulässiger Durchlaßstrom bei Aussetzbetrieb / Max. allowable on-state current at intermittent operation $I_{TINT} = f(ED)$
 Verstärkte Luftkühlung / Forced air-cooling, $t_A = 35^\circ\text{C}$
 Kühlkörper / Heatsink: K0,12F, $v_L = 50\text{ l/s}$
 Parameter: Spieldauer / Cycle duration SD
 Vorlaststrom / Pre-load current $I_{TAV(vor)}$

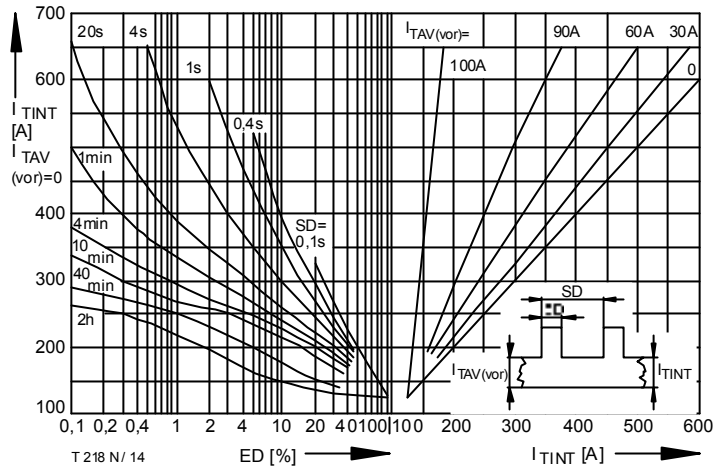

Bild / Fig. 16
 Grenzzstrom / Max. overload on-state current $I_{T(OV)M} = f(t)$, $v_{RM} = 0,8 V_{RRM}$
 Luftselbstkühlung / Natural air-cooling, $t_A = 45^\circ\text{C}$
 Verstärkte Luftkühlung / Forced air-cooling, $t_A = 35^\circ\text{C}$
 Kühlkörper / Heatsink: K0,36S, K0,12F
 Belastung aus / Surge current occurs:
 a - Leerlauf / No-load conditions
 b - Betrieb mit Dauerrenzstrom / During operation at max. average on-state current I_{TAVM}

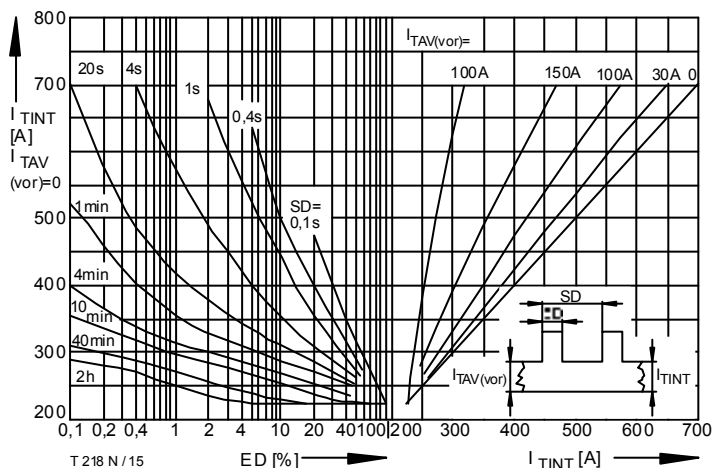

Bild / Fig. 17
 Steuercharakteristik mit Zündbereichen / Gate characteristic with triggering areas $v_G = f(i_G)$, $v_D = 6\text{ V}$
 Parameter:

	a	b	c
Steuerimpulsdauer / trigger puls duration t_g [ms]	10	1	0,5
Höchstzulässige Spitzensteuerleistung / Max. rated peak gate power dissipation [W]	20	40	60

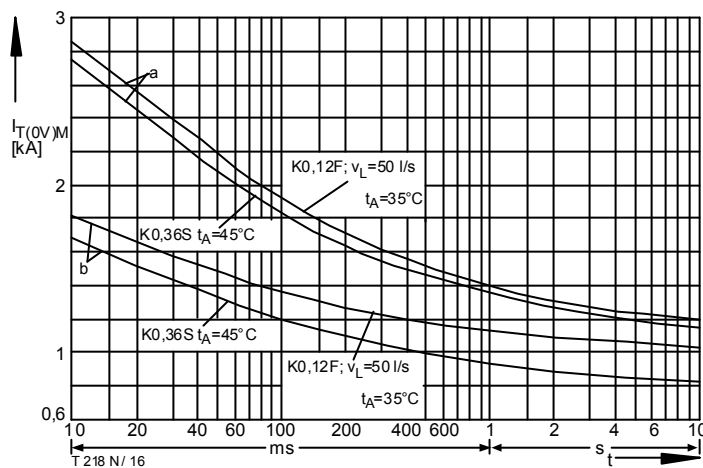

Bild / Fig. 18
 Zündverzögerung / Gate controlled delay time $t_{gd} = f(i_{GM})$
 $t_{vj} = 25^\circ\text{C}$, $di_G/dt = i_{GM}/1\mu\text{s}$
 a - Maximaler Verlauf / Limiting characteristic
 b - Typischer Verlauf / Typical characteristic

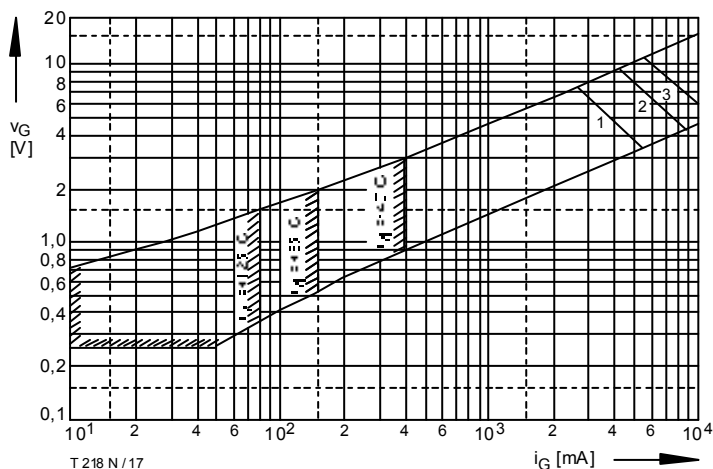

T 218 N / 19

Bild / Fig. 19
 Sperrverzögerungsladung / Recovered charge $Q_r = f(di/dt)$
 $t_{vj} = t_{vj \max}$, $V_R = 0,5 V_{RRM}$, $V_{RM} = 0,8 V_{RRM}$
 Parameter: Durchlaßstrom / On-state current i_{TM}

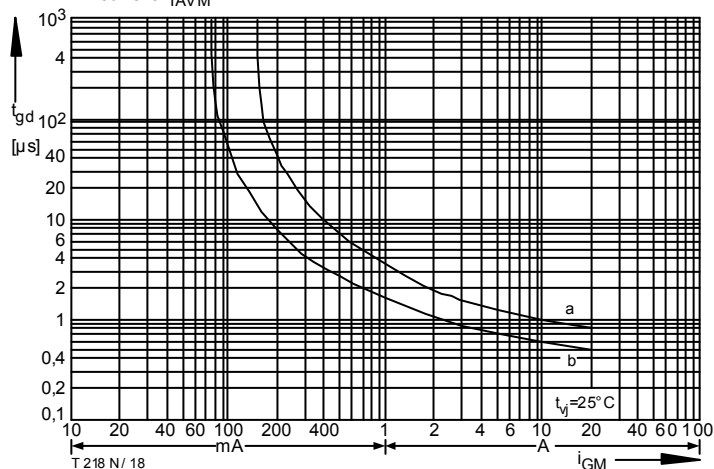
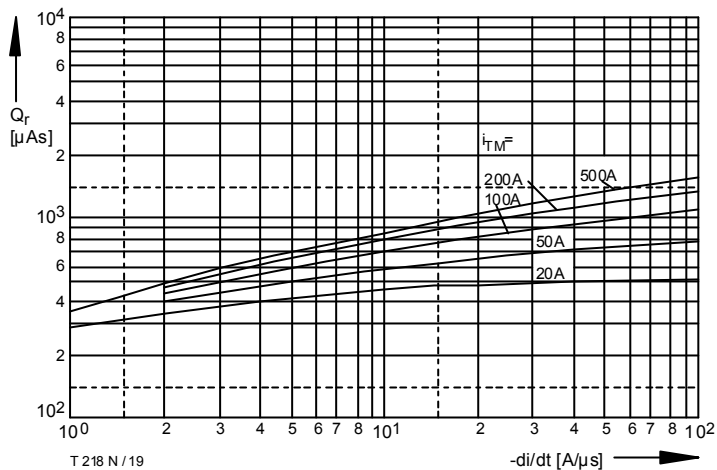

Bild / Fig. 20
 Transienter innerer Wärmewiderstand / Transient thermal impedance
 $Z_{thJC} = f(t)$
 - - - - - Anodenseitige Kühlung / Anode-sided cooling
 ————— Beidseitige Kühlung / Two-sided cooling
 Parameter: Stromflußwinkel / current conduction angle θ



T 218 N / 21

Bild / Fig. 21
 Transienter innerer Wärmewiderstand / Transient thermal impedance
 $Z_{thJC} = f(t)$
 - - - - - Anodenseitige Kühlung / Anode-sided cooling
 ————— Beidseitige Kühlung / Two-sided cooling
 Parameter: Stromflußwinkel / current conduction angle θ

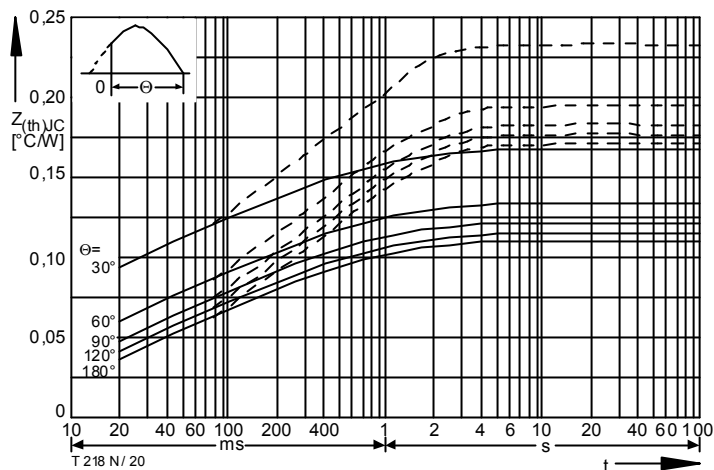
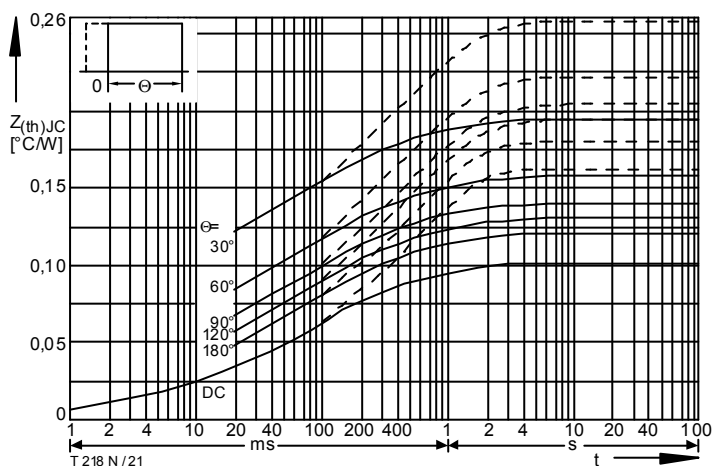
Analytische Elemente des transienten Wärmewiderstandes Z_{thJC} pro Zweig für DC
 Analytical elements of transient thermal impedance Z_{thJC} per arm for DC

Beidseitig / Two-sided

Pos. n	1	2	3	4	5
R_{thn} [$^{\circ}\text{C}/\text{W}$]	0,00727	0,0232	0,0497	0,00982	0,013
τ_n [s]	0,000731	0,0144	0,0993	0,413	1,51

Anodenseitig / Anode-sided

Pos. n	1	2	3	4	5
R_{thn} [$^{\circ}\text{C}/\text{W}$]	0,00809	0,0295	0,0507	0,0725	0,0052
τ_n [s]	0,000855	0,0181	0,188	0,96	4,85

Kathodenseitig / Cathode-sided

Pos. n	1	2	3	4	5
R_{thn} [$^{\circ}\text{C}/\text{W}$]	0,00929	0,0331	0,0735	0,102	0,0477
τ_n [s]	0,00103	0,0219	0,34	1,81	11,8

Analytische Funktion / Analytical function:

$$Z_{thJC} = \sum_{n=1}^{n_{\max}} R_{thn} \left(1 - e^{-\frac{t}{\tau_n}}\right)$$